

EVAP COOLER DROPPERS WEATHER-GUARD DROPPER & FLASHING

AdvantageAir

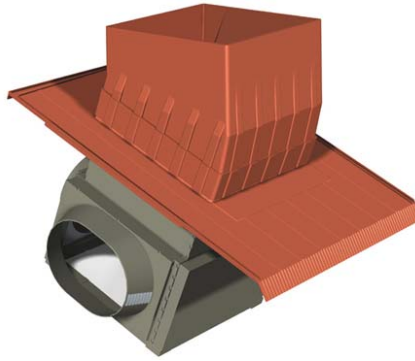

FEATURES

- Low cost.
- UV stabilised to prevent degradation of materials.
- Quick to install.
- Will not corrode.
- No joints therefore less potential leaks.
- Coloured to match evaporative units. The following colours are available.
 - * Terracotta
 - * Caulfield Green
 - * Beige
 - * Slate grey
 - * Chocolate Brown
 - * Mist Green
- Paint will not scratch during transport or installation.
- Suitable for metal or tile roofs.
- Will cater for roof pitches 14° to 30°
- Suitable for low profile and standard evaporative units.
- Clip on adapters saves time.
- Can be configured with one, two, three, four or five outlet connections.
- Outlet sizes up to 550 diameter.
- Contoured flashing prevents dirt and moisture damming on high side of flashing.
- Double gutter to ensures no water can be blown up the flashing and into the roof space.
- Tabs on underside of flashing enable the flashing to be screwed to the roof structure.
- Thick plastic construction provides excellent insulation of all exposed walls.
- Ovalised spigot connections optimise air flow.
- Compact dropper enables unit to be mounted lower on the roof improving overall system aesthetics.
- Angled flashing end of can be trimmed or heat moulded to provide an attractive joint where flashing meets tiles or roof sheet.

APPLICATIONS

- Ideal for domestic evaporative cooler installations with corresponding connection sizes.

CONSTRUCTION

- Angle and straight tops are moulded from 8mm (average thickness) engineering polymers with UV stabilisers.
- Flashing is moulded from engineering polymers with maximum UV stabiliser.
- Base is moulded from ABS plastic.
- All screws are supplied and are corrosion resistant.

OPTIONAL EXTRAS

- The type of top is an optional extra and must be specified at the time of ordering.
 - * An angle top is suitable for standard units with a 550x550 opening.
 - * A straight top is suitable for Breezeair Contour range.
 - * Colour bond top for Brivis Contour units.
- The number of outlets must be specified at the time of ordering. The bottom outlet is an optional extra.
- Non return dampers can be supplied as an optional extra.

DIMENSIONS

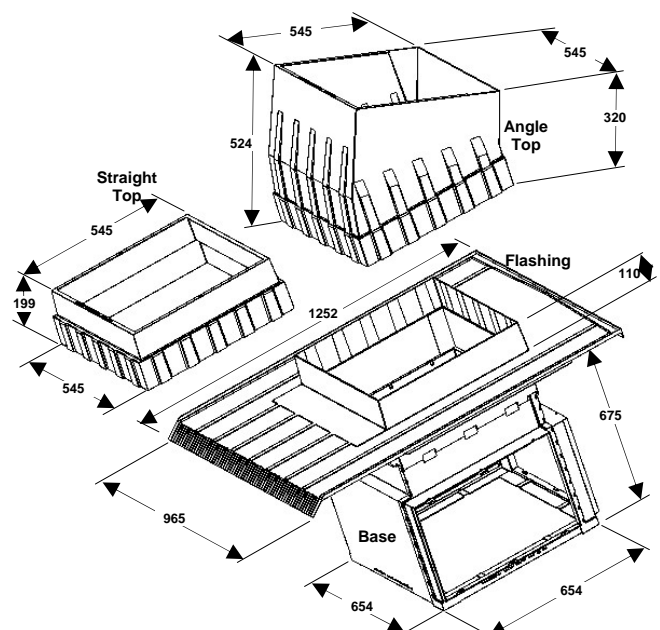

EVAP COOLER DROPPERS WEATHER-GUARD - INSTALLATION

AdvantageAir

INSTALLATION

1. You will require the following minimum roof space measured perpendicular to the tiles or metal roof for each configuration:
One, two or three way droppers - 675 mm
Four way droppers - 850 mm
Five way droppers - 1200 mm

Ensure there are no structural timbers likely to obstruct the take-offs.

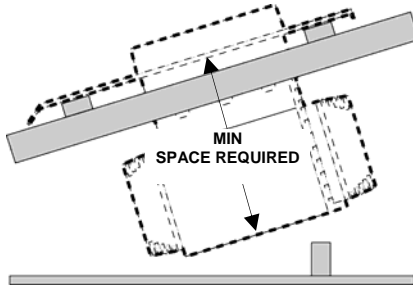

2. (a) If a tile roof, remove tiles and trim tile batons to provide an opening **550mm wide x 680mm long**.
(b) If a metal roof, cut opening in roof sheet and trim batons To provide an opening of **550mm wide x 680mm long**.
3. Pass the assembled dropper base through the opening and carefully place on the ceiling. If using 5 outlets it may be necessary to unscrew the bottom outlet to enable it to pass through the roof opening.

2. (a) Tile

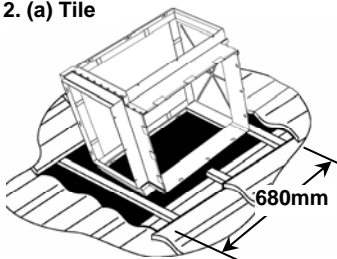

2. (b) Metal

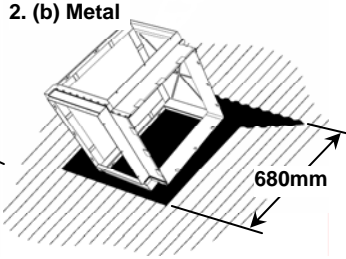

4. Pack the opening with timber off cuts if the distance between trusses exceeds 550mm.

Tile

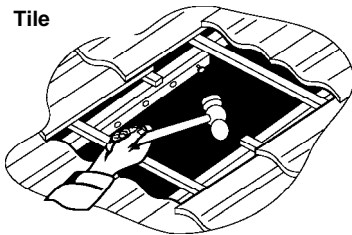

Metal

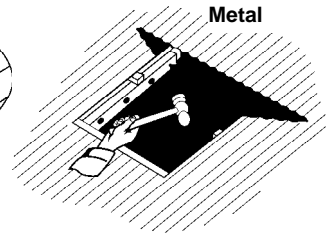

5. Install the flashing into the hole.

(a) For tile roofs, ensure the top of the flashing is clear of the tile batons as indicated below.

(b) For metal roofs, slide flashing underneath the top cut.

5. (a) Tile

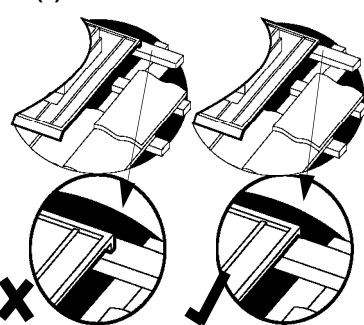

5. (b) Metal

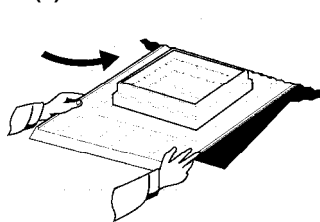

6. Ensure flashing is square with the roof tiles/roof line and using the hexagonal head screws provided, loosely install one screw per side to hold the flashing in place. **DO NOT FASTEN THESE TWO SCREWS.**

Tile

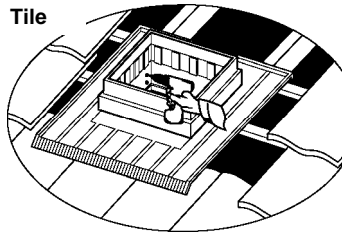

Metal

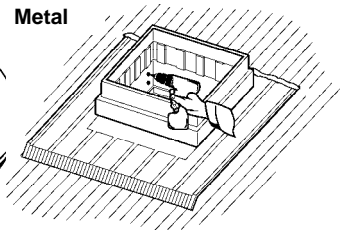

7. From inside the roof space ensure the orientation of the dropper base is correct. Clip the dropper base onto the underside of the flashing. Ensure there are no obstructions to the flexible duct adaptors.

Tile

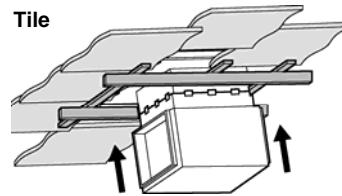

Metal

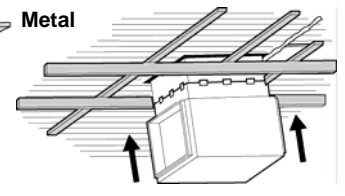

8. Install the remaining screws into the flashing and fasten. Use five screws on each rafter in the positions shown below.

5 HEX HEAD SCREWS
PER RAFTER

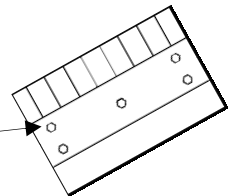

9. For tile roofs only, trim & replace tiles over flashing.

10. For tile roofs only, fasten flashing down to roof batons via end tabs to obtain required curve in the flashing. (These screws are not provided).

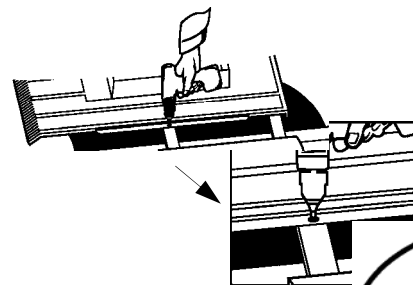

PHILLIPS HEAD
SCREW

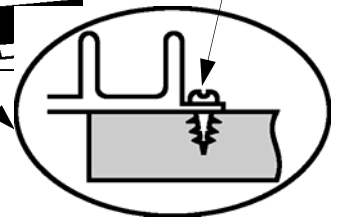

11. Place the required top section on the flashing:

Angled top for most common units.

Straight top for Breezair contour units

Tile

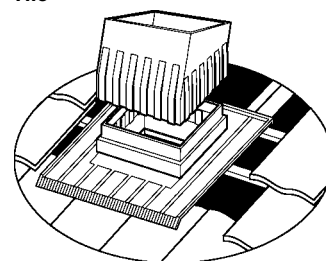

Metal

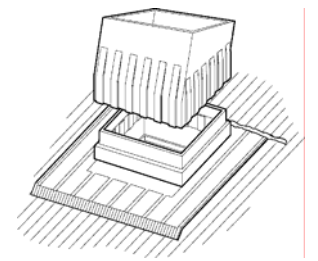

No liability

Make sure you read and understand all the installation instructions before you install this Weather Guard dropper. Advantage Air (Aust) Pty Ltd does not accept any responsibility for any loss or damage that may be caused either directly or indirectly by the installation of this Weather Guard dropper.

EVAP COOLER DROPPERS WEATHER-GUARD - INSTALLATION

AdvantageAir

12. Place a level on the angle top and while keeping one edge down hard tilt the angle top until it is level.

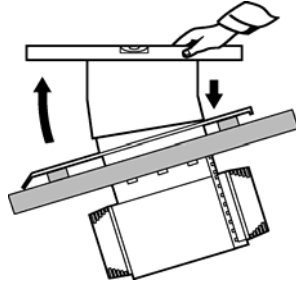

13. Using 12 Hex head screws provided, work from the outside of the dropper, fix one screw to each corner at the lowest end. These two screws will act as a hinge. Check the level of the top and install the remaining screws to the sides, front and back. To maintain the integrity of the dropper it is very important to only fix the screws in the thick sections of the flashing upstand in the positions illustrated. Tighten screws gently to avoid stripping the thread. If required, extra similar screws can be placed in the remaining thick sections.

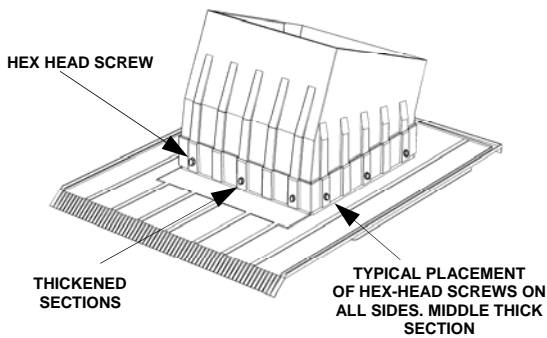
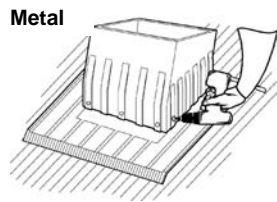
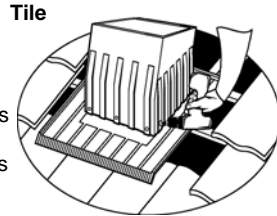

14. Run a bead of clear silicon along the inside of the joins if necessary.

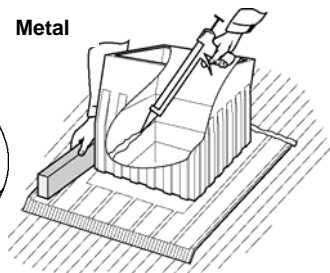
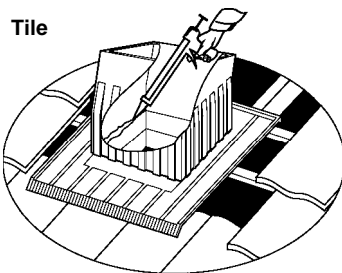

15. If it is desirable to trim the top of the dropper do not trim off more than 100mm. Place the unit on top of the dropper, level and fix in position.

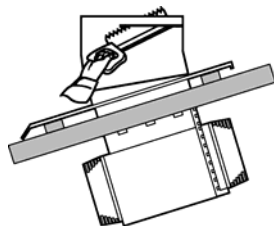

16. For tile roofs only, replace roof tiles on the sides and trim tiles as usual to obtain a weather proof seal.

17. For metal roofs only, apply silicon to where flashing meets roof sheet.

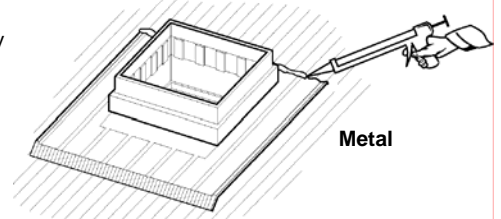

18. The front of the flashing can be trimmed with a Stanley knife to shape the front of the flashing to the roof profile, for both metal and tile roofs. Suitable roofing screws can also be used to screw the flashing down neatly to metal roofs only if desired. (These screws are not provided).

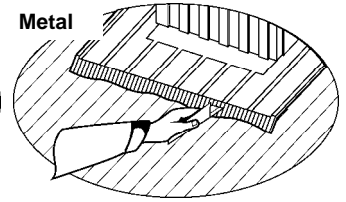
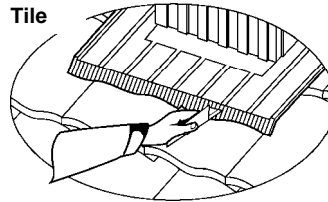

19. Drill holes required for water supply and drain in the raised section on the front or side of the flashing.

20. Install pipework and silicon penetrations as normal. If copper pipe is used it should not be in contact with any plastic parts.

21. From inside the roof space, check the dropper base is securely clipped to the flashing if in doubt use self tapping screws.

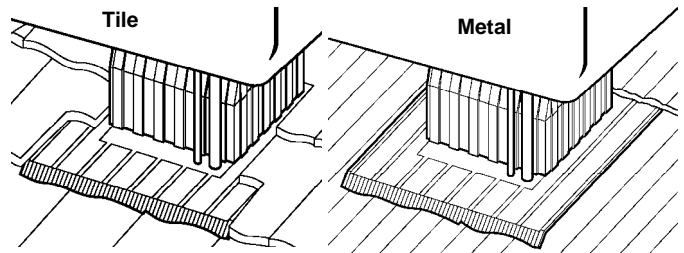

22. Drill hole in flashing for electrical cables.

23. Pull power and controls cable through hole, insert grommet (provided by evap unit manufacturer) and secure using silicon.

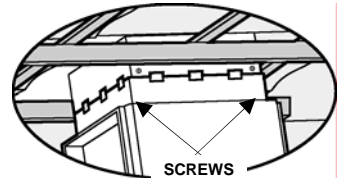

24. After taping the flexible duct to the neck adapters carefully clip the adapters onto the dropper base.

25. Ensure there are no sharp bends or distortions in the flexible duct at the dropper base.

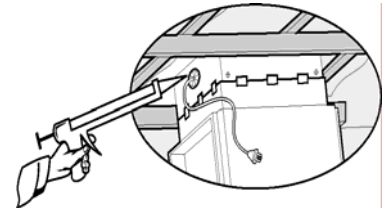

26. It is recommended that the flexible duct is supported using hanging strap 1 meter from the dropper base.

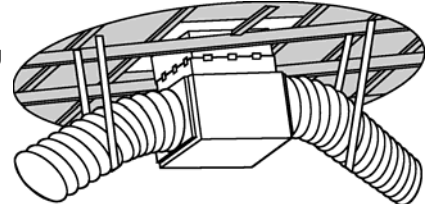

27. Once the unit is running check all connections are secure.

28. Please recycle all packaging.



No liability

Make sure you read and understand all the installation instructions before you install this Weather Guard dropper. Advantage Air (Aust) Pty Ltd does not accept any responsibility for any loss or damage that may be caused either directly or indirectly by the installation of this Weather Guard dropper.

EVAP COOLER DROPPERS FLEXIBLE DROPPER EXTENSION

AdvantageAir

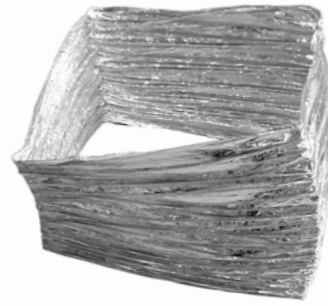

CONSTRUCTION

- Square Reinforced Duct
- Installation - should be screwed & taped to the flashing and dropper base

APPLICATIONS

- Dropper extension
- Provides flexibility to accommodate structural roof timbers
- Can be cut to required length

PERFORMANCE

- Sharp bends in the flexible dropper extension may adversely affect the system performance.
- This product is not designed to support the weight of the dropper base. Installation should ensure the base of the dropper is supported.

DIMENSIONS

