

PLASTIC DIFFUSERS AND GRILLES

SUNLINE DIFFUSER

AdvantageAir



FEATURES

- Available in 3 different sizes:
 - 200 dia
 - 250 dia
 - 300 dia
- Stylish design
- Easily adjusted diffuser opening
- Low cost
- Lightweight rigid construction
- Easy to clean.
- Scratch resistant surface.
- Quiet.
- Snap action clips for fast and easy installation.
- Tapered neck for easy duct connection

CONSTRUCTION

- These outlets are injection moulded from white ABS plastic and have integrated spring loaded clips

APPLICATIONS

- Ideal for residential and commercial reverse cycle air-conditioning, heating and ventilation applications.

OPTIONAL EXTRAS

- Available in motorised/remote controlled option. (See Sunline Remote in the "Controls" section of the Technical Catalogue for further details.)

DIMENSIONS

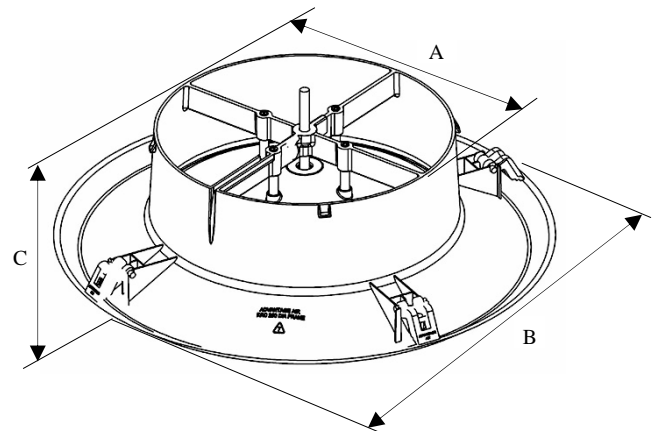

Grille Size	A Nominal Neck Size (mm)	B Flange Size (mm)	C Height (mm)	Hole Diameter (mm)
200 DIA	200	364	114	314
250 DIA	250	413	114	364
300 DIA	300	464	114	414

PLASTIC DIFFUSERS AND GRILLES

SUNLINE DIFFUSERS - PERFORMANCE DATA



200 DIA SUNLINE DIFFUSER

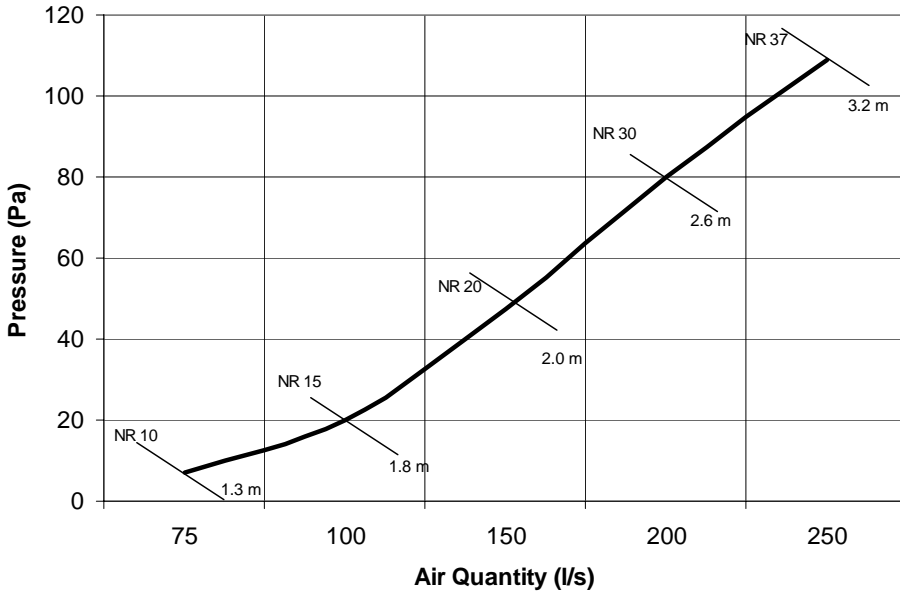

250 DIA SUNLINE DIFFUSER

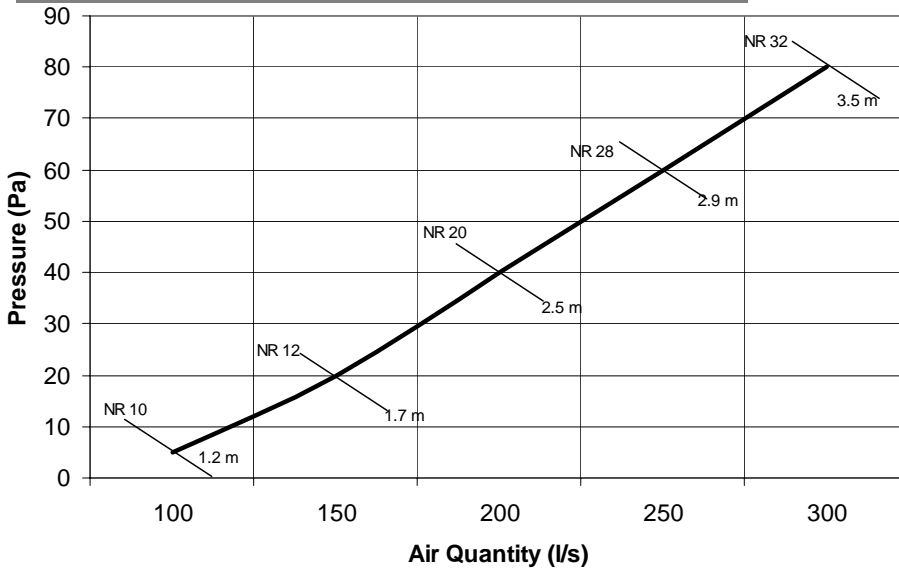

300 DIA SUNLINE DIFFUSER

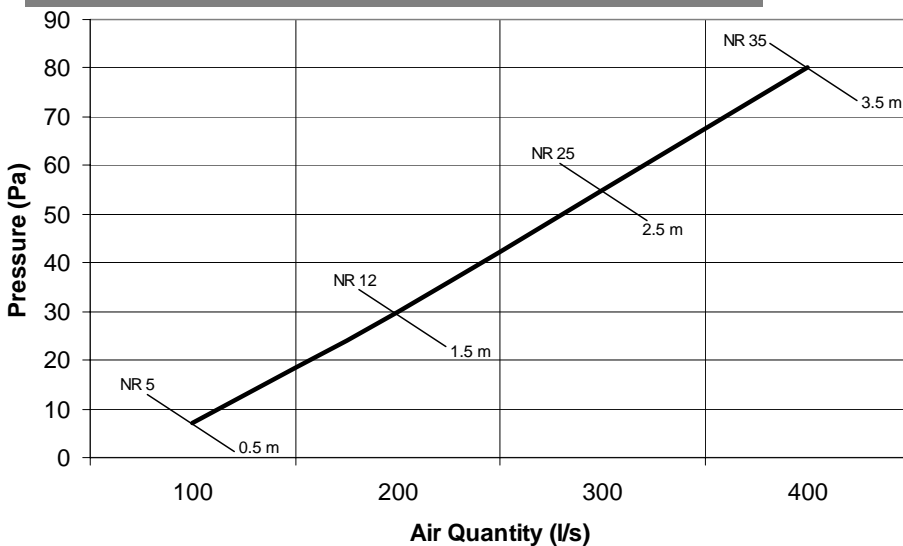

PLASTIC DIFFUSERS AND GRILLES

SUNLINE DIFFUSER

INSTALLATION INSTRUCTIONS

AdvantageAir

1. Select the required position for the grille. Ensure there are no obstructions above the ceiling in the selected location. Using the template provided, mark hole for the grille as follows:

200 diameter grille: **hole sizes 314mm dia.**
250 diameter grille: **holes size 364mm dia.**
300 diameter grille: **holes size 414mm dia.**

2. Carefully cut opening in ceiling.

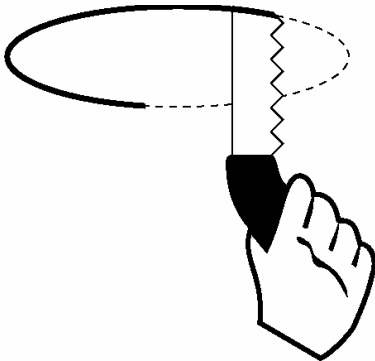

3. Pull the duct through the opening in the ceiling and attach the grille to the duct using duct tape.



4. Load the clips in the upright position. TAKE CARE you do not accidentally trigger a clip and catch your finger.

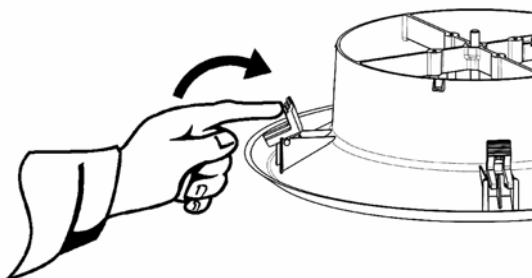

5. Carefully pass the grille up into the opening ensuring all clips are triggered down.

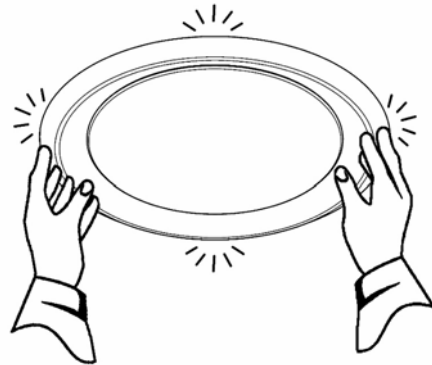

6. Adjust the air quantity by spinning the diffuser cone clockwise or anticlockwise.

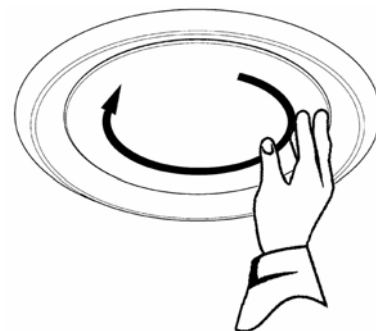

Clockwise to close

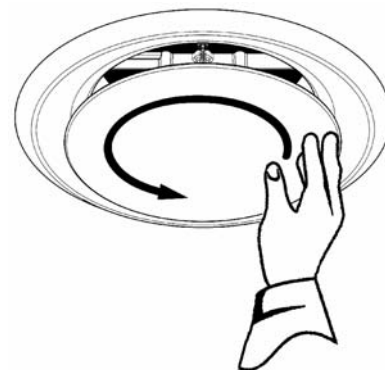

Anticlockwise to open

8. To clean grille wipe down with warm soapy water.

9. Please recycle all packaging.



No liability

Make sure you read and understand all the installation instructions before you install this Sunline diffuser. Advantage Air (Aust) Pty Ltd does not accept any responsibility for any loss or damage that may be caused either directly or indirectly by the installation of this Sunline diffuser.